



**TALADRO MARTILLO 1/2" M12 FUEL  
+ LLAVE DE IMPACTO 1/4" M12 FUEL**  
2 baterías, cargador y maletín #2598-22  
(062278)



**TALADRO MARTILLO 3/8" M12  
+ LLAVE DE IMPACTO 1/4" M12**  
2 baterías, cargador y maletín  
#2497-22  
(051173)



**BRILLADORA M12**  
2 baterías, cargador y Kit de 5 accesorios  
(1 Borla de lana, 1 esponja amarilla, 1 esponja blanca,  
1 respaldo para pulidora 3", 1 respaldo para lijadora 2")  
#2438-22  
(033961)



**TALADRO MARTILLO DE  
1/2" M12 FUEL** 2 baterías,  
cargador y maletín  
#2504-22  
(060978)



**REMACHADORA M12**  
2 baterías, cargador y maletín  
#2550-22  
(065006)



**DESTORNILLADOR  
COMPACTO DE 1/4" M12**  
2 baterías, cargador y maletín  
#2401-22  
(026795)



**TALADRO ROTOMARTILLO  
DE 3/8" M12** 2 baterías,  
cargador y maletín #2408-22  
(054623)



**CORTADORA TUBOS DE  
COBRE M12** 1 batería,  
cargador y maletín #2471-21  
(069500)



**CHICHARRA M12 FUEL**  
061847 3/8" #2557-22  
061846 1/2" #2558-22



**SIERRA BANDA**  
1 batería, cargador y maletín  
#2429-21XC  
(067079)



**SIERRA SABLE HACKZALL M12**  
1 batería, cargador y maletín  
#2420-21  
(036308)



**GRAPADORA DE 3/8" M12**  
1/4"-9/16" 1 batería,  
cargador y maletín #2447-21  
(072073)





**M18**



**TALADRO MARTILLO DE 1/2" M18 + DESTORNILLADOR DE 1/4" M18** 2 baterías, cargador y estuche #2697-22CT (054624)



**TALADRO MARTILLO DE 1/2" M18** 2 baterías, cargador y estuche #2607-22CT (051172)



**TALADRO DE 1/2" M18** 2 baterías, cargador y estuche #2802-22CT (068207)



**TALADRO DE 1/2" FUEL M18** 2 baterías, cargador y estuche  
052711 Rotomartillo #2804-22  
054060 Destornillador #2803-22



**LLAVE DE IMPACTO DE ALTO TORQUE DE 3/4" M18** 2 baterías, cargador y estuche #2864-22 (064174)



**LLAVE DE IMPACTO DE ALTO TORQUE DE 1/2" M18** 2 baterías, cargador y estuche #2767-22 (060979)



**LLAVE DE IMPACTO TORQUE MEDIO DE 1/2" M18** 2 baterías, cargador y estuche #2860-22CT (062279)



**LLAVE DE IMPACTO DE ALTO TORQUE DE 1" M18** 2 baterías, cargador y estuche #2867-22 (069416)



**DESTORNILLADOR DE IMPACTO DE 1/4" M18** 2 baterías, cargador y estuche #2853-22 (056821)



**KNOCKOUT DE 1/2" - 4" M18** 1 batería, cargador y estuche #2676-20 (051179)



**CORTADORA BARRAS ROSCADAS M18** 1 batería, cargador y estuche #2872-21CT (068205)



**BLOWER COMPACTO M18** 1 batería, cargador y estuche #2688-21 (060981)



**TALADRO ROTOMARTILLO DE 1-1/8" SDS PLUS M18**  
2 baterías, cargador, mango auxiliar y estuche #2715-22 (052706)



**TALADRO ROTOMARTILLO DE 1-9/16" SDS MAX M18**  
2 baterías, cargador y estuche #2717-22 (056824)



**TALADRO ROTOMARTILLO DE 1" SDS PLUS M18**  
2 baterías y cargador #2713-22 (063072)



**TALADRO ROTOMARTILLO SDS PLUS DE 7/8" 2 baterías, cargador, mango auxiliar, varilla de profundidad y estuche #2605-22 (011727)**



**PULIDORA DE 7"-9" FUEL M18**  
1 batería, cargador y mango lateral #2785-21HD (064291)



**RECTIFICADOR DE 1/4" M18**  
2 baterías, cargador y maletín #2784-22 (058249)



**DESTUPIDOR DE TUBERIAS M18**  
2 baterías, cargador y cubo de almacenamiento #2772-21 (060982)



**GRAPADORA FUEL M18**  
1 batería, cargador y bulto #2749-21CT (075783)



**MULTITOOL M18 2 baterías, cargador y bulto #2626-22 (036306)**



**ROSCADORA DE TUBOS DE 2" M18**  
2 baterías, cargador, brazo de soporte y estuche #2874-22HD (069417)



**CORTADOR CABLES 600 MCM M18**  
2 baterías, cargador y estuche #2679-22 (064668)



**RADIO RECARGABLE M18**  
cable auxiliar de 40 cm #2792-20 (054840)



**LÁMPARA LED M18**  
con tripode #2131-20 (068245)



**SIERRA DE CADENA 16" M18**

1 batería y Barra, cadena de Oregon 16" y cargador #2727-21HD (064290)

**TRIMMER DE SIERRA M18**

1 batería y cargador #2726-21HD (059778)

**SOPLADOR FUEL M18**

1 batería y cargador #2724-21HD (061844)

**TRIMMER DE CUERDA M18**

1 batería y cargador #2725-21HD (059777)



**SIERRA CALADORA M18** 1 batería, protector contra astillas, hoja para sierra, cargador y estuche ##2737-21 (067078)

**SIERRA DE MESA DE 8.1/4" M18**

1 batería, cargador, paletas antipatinaje, cuchilla, protector, calibre de inglete y cuchillo de rescate #2786-22HD (064292)

**CORTADORA DE MANO PARA CONCRETO 9" M18**

2 baterías, cargador, disco, disco para metal y estuche #2736-21HD (072074)

**SIERRA DE 12" M18**

1 batería y cargador #2739-21HD (072077)



**TALADRO ROTOMARTILLO SDS**  
1.1/8" 8 Amp 0 - 1,500 RPM  
#5268-21  
(038825)



**TALADRO ROTOMARTILLO SDS**  
1.1/32" 6.4 Amp 0 - 1,500 RPM  
#5386-21  
(028710)



**TALADRO ROTOMARTILLO SDS**  
7/8" 6.4 Amp 0 - 1,290 RPM  
#5485-21  
(006331)



**TALADRO ROTOMARTILLO SDS  
MAX** 1.9/16" 10.5 Amp 0 - 450 RPM  
#5317-21  
(052709)



**TALADRO ROTOMARTILLO SDS  
MAX** 1.3/4" 14 Amp 350 - 450 RPM  
#5546-21  
(025096)



**TALADRO ROTOMARTILLO 1"**  
8 Amp 0 - 1,500 RPM #5262-21  
(011726)



**TALADRO ROTOMARTILLO**  
1/2" 8.5 Amp Dual torque  
#5387-20  
(000464)



**DESTORNILLADOR**  
6.5 Amp 0 - 2,500 RPM  
#6791-21  
(089917)



**BLOWER DE CALENTAMIENTO**  
11.6 Amp 120 V  
001896 #8977-20  
033313 #8975-6



**TALADRO ROTOMARTILLO  
de 1/2"**  
006334 7.5 Amp #5375-20  
052710 5.6 Amp #5374-20



**TALADRO REVERSIBLE**  
1/2" 5.5 Amp #0234-6  
(021531)



**TALADRO REVERSIBLE 3/8"**  
006333 5.5 Amp #0233-20  
090585 7 Amp #0200-20



**TALADRO ROTOMARTILLO  
de 1/2" 7 Amp**  
021532 650 RPM #1610-1  
090584 450 RPM #1660-6



**DIFERENCIAL  
ELÉCTRICO 20'**  
088397 1 ton #9568  
088398 2 ton #9573



**SIERRA TRONZADORA 14"**  
15 Amp 3,900 RPM #6177-20  
(021558)



**SIERRA MITER SAW 12"**  
15 Amp 3,200 RPM #6955-20  
(023363)



**SIERRA DE BANDA 1"**  
6.5 Amp 0 - 3,000 SPM  
#6238-20  
(091585)



**SIERRA CALADORA 1"**  
6.2 Amp 500 - 3,000 RPM  
#6276-21  
(017863)



**SIERRA CIRCULAR 15 Amp**

082730 10.1/4" 5,200 RPM  
#6470-21

017362 7.1/4" 5,800 RPM  
#6430-20

009984 7.1/4" 5,800 RPM  
#6390-20



**SÚPER SIERRA SAWZALL**

021560 1.1/4" 13 Amp  
0-3,000 SPM #6536-21

038897 1.1/8" 12 Amp  
3,000 SPM #6519-30



**SIERRA PARA METAL 8"**

15 Amp 3,700 RPM  
#6370-21  
(098212)



**SIERRA PARA METAL 4"**

11 Amp 300 -380 RPM  
#6268-21  
(099931)





**TALADRO BASE  
ELECTROMAGNÉTICA**  
1.5/8" 13 Amp 475 RPM  
#4272-21  
(052081)



**BRILLADORA 7/9"**  
11 Amp 0 - 1,750 RPM #5460-6  
(099928)



**PULIDORA 4.1/2"**  
006142 7 Amp 11,000 RPM  
#6130-33  
024483 7.5 Amp 10,000 RPM  
#6140-30  
058029 11 Amp 11,000 RPM  
#6141-31



**PULIDORA 7" 15 Amp**  
038826 8,500 RPM #6086-30  
099929 6,000 RPM #6088-30



**PULIDORA 9"**  
15 Amp 6,000 RPM #6660-6  
(085317)



**CIZALLA CORTADORA**  
021933 Calibre 14 5 Amp #6815  
099930 Calibre 18 6.8 Amp #6852-20



**RECTIFICADOR 4.5 Amp**  
21,000 RPM #5194-1  
(021561)



**ESMERILADORA 6"**  
15 Amp 5,500 RPM #5243-1  
(021543)



**LIJADORA ORBITAL 3 Amp**  
051171 5" #6034-21  
052708 1/4" #6033-21



**ROUTER**  
093463 1.3/4 HP 11 Amp  
24,000 RPM #5615-21  
095664 2.1/4 HP 13 Amp  
10,000 - 24,000 RPM #5616-21



**ROUTER 3.1/2 HP 15 Amp**  
10,000 - 22,000 RPM #5616-21  
(097136)



SIERRAS COPA

PINZAS



CINTAS MÉTRICAS



DESTORNILLADORES



BATERÍAS

AMPLIA VARIEDAD EN

ACCESORIOS Y  
HERRAMIENTAS  
MANUALES



DETECTORES DE VOLTAJE



CINCELOS



AMPERÍMETROS



GUANTES



INFLADORES



ORGANIZADORES



MULTÍMETROS



TERMÓMETROS



BARRENAS DE DIAMANTE



BARRENAS



DISCOS



LINTERNAS



COLECTORES DE POLVO



SOLDADORES



CUCHILLAS



**LLAVE TORQUE**

055925	1" 200-1000 lbs/pie
055924	3/4" 150-750 lbs/pie
039194	3/8" 10-80 lbs/pulg



**LLAVE AJUSTABLE**

016889	10"
034532	12"
027496	24"

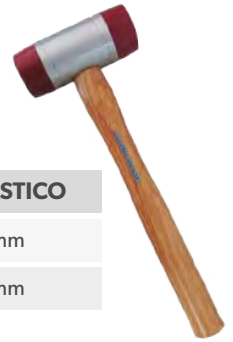

**MARTILLO PLASTICO**

018354	35mm
018355	45mm



**JUEGO LLAVE ALLEN**  
9 pcs 1.5-10mm  
(031571)



**ALICATE COMBINADO**  
9"  
(055048)



**PISTOLA DE IMPACTO NEUMATICA**

034531	1" de 1500 pies/lbs
034553	1/2" de 500 pies/lbs
034554	3/4" de 800 pies/lbs



**ARMARIO P/HERRAMIENTAS**

051666	Vacio
023154	Incluye Herramientas



**ALICATE FLEXIBLE**  
para abrazaderas  
(055057)



**CAJA DE HERRAMIENTAS**  
3 Sec. 470 X 220 X 345 mm  
(018359)



**JUEGO DESTORNILLADOR**  
Estria / Plano 7/1"  
(050988)



**MANGO ATRICULADO**  
3/4" X 18"  
(055050)

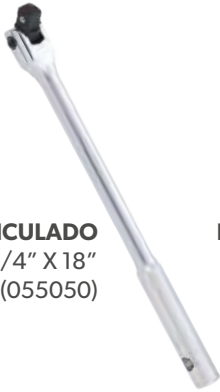

**PALOTE CORREDIZO**  
3/4" X 20"  
(018194)



**CHICHARRA REV.**  
1/2" X 10"  
(018154)



**ALICATE PRESION CURVO**  
10"  
(016890)



**JUEGO EXTRACTOR** con mango del tirador del engranaje  
(061471)

**JUEGO DE LLAVES COMBINADA**  
26/1 de 6-32mm  
(023161)



**COMPRESOR VÁLVULAS**  
10 pcs  
(058270)

**JUEGO DE CUBOS**  
16 Pcs conex.  
1/4" 4-13mm  
(011281)



**JUEGO DE CUBOS**  
16 Pcs conex.  
3/4" dobe hex  
(018190)





**SOPORTE PARA MOTORES**  
(099382)



**GATO PARA TRANSMISIÓN**  
(099384)



**TRÍPODE DE DOBLE SEGURIDAD**

087550 2 t  
087551 3 t  
087552 6 t



**GATO HIDRÁULICO TIPO RANA HEAVY DUTY**

087577 3 t      087545 5 t  
087543 3.25 t      087546 10 t  
087575 4 t



**GATO HIDRÁULICO TIPO RANA**

087544 2 t  
087539 3 t



**GATO TIPO TIJERA**

087548 1.5 t  
087549 2 t



**CUÑAS PARA RUEDAS**  
(099380)



**GATO HIDRÁULICO BOTELLA**

087515 2 t      087528 12 t  
087516 4 t      087529 16 t  
087519 6 t      087530 20 t  
087521 8 t      087531 30 t  
087522 10 t      087532 50 t



**BOTELLA HIDRÁULICA PARA GRÚA**  
(099383)



**CARRETE CON MANGUERA**  
3/8" X 50'  
PARA AIRE  
(046893)



**RAMPA PARA VEHÍCULOS**  
2.5 t  
(087568)



**GATO NEUMÁTICO BOTELLA**  
20 t  
(099386)



**HERRAMIENTA PARA ARREGLAR FRENOS**  
(087574)



**DREMEL NEUMÁTICO**  
con accesorios 10pcs  
(099392)



**JUEGO DE MANIFOLD**  
(099389)



**EQUIPO DESABOLLADOR  
HIDRÁULICO**

- 087547 4 t
- 087576 10 t



**CARRETILLA HIDRÁULICA**  
27" x 48" 3000 kg  
(099391)



**APILADOR HIDRÁULICA**  
Manual 2,000 Kg  
(087566)



**CAMILLA PARA MECÁNICOS**  
(099385)



**ASIENTO NEUMÁTICO**  
Para mecánicos  
(087567)



**GRÚA PLEGABLE**  
087553 1 t  
087554 2 t



**BALANCEADOR  
DE NEUMÁTICOS**  
24" 110-220V/60HZ/1P  
(046888)



**DESMONTADOR DE GOMAS**  
Para aros de vehículos  
13 pulg - 38 pulg  
(087564)



**PRENSA HIDRÁULICA**  
087555 20 t  
087561 30 t  
087562 50 t

# STANLEY®



**LAPEADORES DE VÁLVULAS**  
(056205)



**LLAVE AJUSTABLE**  
Cromada 10"  
(021147)



**ALICATE CORTE DIAGONAL 7"**  
(095671)



**ALICATE COMBINADO**  
8" con forro  
(098842)



**SERRUCHO ECONÓMICO 26"**  
(010159)



**CIZALLA PARA CORTAR VARILLAS**  
18"  
(010159)



**JUEGO DE LLAVES COMBINADAS**  
8/1 5/16" - 3/4"  
(099784)



**JUEGO LLAVES ALLEN 10 Pcs**  
(013497)



**CAJA PARA HERRAMIENTAS RODANTE**  
(054363)



**CINTA MÉTRICA METAL**  
021108 5M/16' x 3/4"  
087370 8M/25' x 1"  
Power Lock



**ABOCINADOR**  
(023133)



**CAJA PARA HERRAMIENTAS**  
19"  
(029889)



**CAJA METÁLICA PARA HERRAMIENTAS**  
(021094)



**CUCHILLA  
RETRÁCTIL**  
(089160)



**ALICATE DE  
PRESIÓN  
RECTO 10"**  
(085502)



**MARTILLO  
CARPINTERO  
PULIDO 20 Oz**  
(021154)



**LLAVE TORQUE  
DE AGUJA**  
conex. 1/2  
0-150 Lbs  
(098836)



**CUBO BIT**  
Conex. 1/2" x 5/8"  
(054864)



**JUEGO DESTORNILLADOR  
6/1 Pro**  
(013496)



**ALICATE Y LLAVES AJUSTABLES  
4/1**  
(000781)



**COMPRESIMETRO  
DE MANGUERA 0-300 Psi**  
(057330)



**ESPATULA**  
023136 10"  
023137 12"

**HIDROLAVADOR  
DE ALTA PRESIÓN**

- 059622 1740 PSI 1600W
- 059623 1885 PSI 1800W
- 059624 2103 PSI 1900W



**JUEGO DESTORNILLADOR  
7/1 1000V**  
(008891)



**JUEGO DE CUBOS HEXAGONALES**  
083938 Conex. 1/2" 14/1 3/8"-1"  
026087 Conex. 1/2" 25/1 10-17mm



**ALICATE DE PRESION  
SARGENTO**  
Tipo C 18"  
(021311)

**JUEGO DADOS Y MACHOS**  
76/1  
(016967)



**MARCO SEGUETA**  
019861 Alta tensión  
019862 Media tensión

**SERRUCHO**  
024041 20"/500mm  
024042 22"/550mm



**SERRUCHO CALADOR**  
6" manual para yeso  
(024047)



**JUEGO LLAVES ALLEN**  
25/1  
(067083)

**PRENSA DE BANCO**  
019855 4"  
019856 5"  
016960 6"





**SARGENTO MARIPOSA**  
3"  
(019852)



**PRENSA DE RESORTE**  
3"  
(067082)



**PRENSA DE MANO CON GATILLO**  
(019850)



**ALICATE ELECTRICISTA**  
9.1/2"  
(016186)



**ALICATE CORTE**  
8"  
(016188)



**ALICATE ELECTRICISTA**  
8.1/2"  
(015897)



**TIJERA PARA HOJALATERO**  
(024046)



**ALICATE PRESION PUNTA AGUJA**  
Mango de goma con corte 9"  
(034308)



**ALICATE MECANICO**  
8"  
(016190)



**PUNTA DE DESTORNILLADOR ESTRIA**  
Set 25 Pcs (009219)



**PUNTA ESTRIA DE IMPACTO #3**  
(056747)



**AVELLANADOR**  
3/4"  
(090134)



**PUNTA ESTRIA N.2" X 3.5"**  
(062305)



**EXTRACTOR DE TORNILLOS Ex-6**  
(010389)



**DISCO DE PULIR CLASSIC**

058831 4.1/2 x 1/4"

058832 7 x 1/4"



**PIEDRA WIDIA P/ AFILAR VERDE**

020056 152 x 19 x 31 mm G-100

020060 152 x 25 x 31 mm G-120

020066 254 x 25 x 38 mm G-120



**PIEDRA CIRCULAR P/ ESMERILAR**

020029 127 x 25 x 31 mm G-36

020034 152 x 19 x 31 mm G-60

020040 203 x 25 x 31 mm G-60

020042 254 x 25 x 38 mm G-46

020047 304 x 38 x 38 mm G-24



**DISCO DE LIJA**

033263 4.1/2" G-100

033264 4.1/2" G-120

004498 7" G-16

004497 7" G-120



**DISCO DE PULIR/FLAP DISC**

088205 7 x 7/8" G-60

027328 3 x 1 x 1/4" G-80



**CINTA ANTIDESLIZANTE**

Clear 2 Pulg x 20 M  
(008444)

020001 2 Pulg x 147.6 Pie G-50

020005 2 Pulg x 150 Pie G-120



**TELA DE ROLLO**



### PIEDRA COPA BLANCA

020020 5 x 2 x 1.1/4" G-46

038577 8 x 4 x 1.1/4" G-60



### PIEDRA BLANCA

020012 7 x 1/2 x 1.1/4" G-60

038575 6 x 1/2 x 1.1/4" G-80

013800 8 x 1 x 1.1/4" G-120



### LIJA PARA FERRE

G-36 Blanca / Amarilla  
(006596)



### LIJA AMARILLA

G-60 / G-125  
(006604)

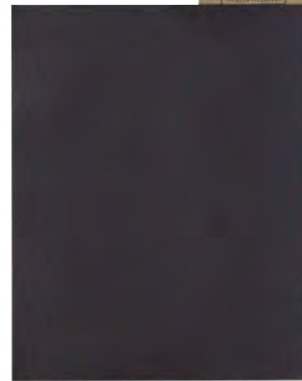

### LIJA DE AGUA

014180 G-80

014191 G-600



### BANDA DE LIJA

058834 3 x 24" G-120

058827 4 x 24" G-80

### PIEDRA MONTADA

020029 127 x 25 x 31 mm G-36

020034 152 x 19 x 31 mm G-60

020040 203 x 25 x 31 mm G-60

020042 254 x 25 x 38 mm G-46

020047 304 x 38 x 38 mm G-24



# MAQUINA DE SOLDAR INVERTER



**200 Amp al 60% de ciclo de trabajo** (Suelta todos los electrodos incluyendo aluminio)  
(050416)



**T40.20PAH/TIG AC/DC**  
(052509)



**Potenza TIG de 170 Amp al 60% de ciclo de trabajo, Monofásica** (Equipo de alta frecuencia p/soldar inoxidable y aceros)  
(052512)



**Potenza 200**  
(050416)



**Multitensión 210 Amp 2100 PFC**  
(054646)



**Progress 1700 PFC bitensión**  
(050417)



**M40.20 MULTI/MIG 200 MULTI**  
(052510)



**PEDESTAL PARA TALADRO**  
60mm  
(050414)



**TALADRO-ATORNILLADOR**  
12V  
(067772)



**TALADRO PERCUTOR**  
12V  
(067773)



**CARETA DE SOLDAR**  
(050418)



**PULIDORA**  
110V  
(057406)



**ATORNILLADOR**  
110V/60Hz/1P  
(067775)



**TALADRO PERCUTOR**  
1/2" 110V/60Hz/1P  
(067776)



**SIERRA RADIAL**  
110/220V  
(058760)



**TALADRO MARTILLO DEMOLEDOR**  
110V/60Hz/1P HD  
(067777)



**CEPILLO PARA MADERA**  
(054640)



**INGLETEADORA TELESCOPICA**  
12" 110V  
(060985)



**DISCO DIAMANTE**

058764 Universal básico 4.1/2"



**DISCO PULIR METAL**

050427 Flap Procer 4.1/2" X 7/8"

054722 Flap Procer 7"

052516 7" X 1/4" X 7/8"



**DISCO CORTE CONCRETO**

050424 9"x5/64"x7/8"



**DISCO CORTE INOXIDABLE**

050421 4.1/2"x1/16"x7/8"

050422 7"x1/16"x7/8"



**SOLDADORA CA/CD**  
TH-235/160 max 225 Amp  
20% ciclo de trabajo  
(080741)



**SOLDADORA**  
TH-250  
(011689)



**MÁQUINA CORTE PLASMA**  
3/4" acero 1/2" aluminio  
220/440V HotPoint750  
(086016)



**SOLDADORA CA**  
TH-225 max 225 Amp  
20% ciclo de trabajo  
(080740)



**SOLDADORA CD**  
MI3-500/47 400 Amp  
ciclo de trabajo trifásico 220/440V  
(086340)



**SOLDADORA MONOFÁSICA**  
40% ciclo de trabajo  
CD 220/440V MI-2-300  
(084993)



**SOLDADORA TRIFÁSICO CD**  
500 Amp 60% ciclo de trabajo  
220/440V MI3-57  
(086341)



**SOLDADURA**

081648	Ferro-niquel 60-1/8"
088634	Acero 6013 - 1/8"x14"
081649	Eléctrica Aluminio 1/8"
095952	Acero básico 7018 - 3/32"
081647	Acero inox. 1/8"x14" 3.2mm



**SOLDADURA ALAMBRE  
ACERO ELECTRICO**

082463	0.035"
082464	0.045"



**PLANTA SOLDADORA CA/CD**  
de gasolina 250 Amp 100% ciclo  
de trabajo 18 HP Bronco-250  
(080742)



**SOLDADORA TIG AC/DC**  
250 Amp 50% ciclo de trabajo  
220/440V MI-2-300  
(089058)



**PLANTA SOLDADORA CD**  
de gasolina 140 Amp 60% ciclo  
de trabajo motor 110 HP Bronco-3700  
(089543)



**REGULADOR**  
para oxígeno  
Silver Star SH-1310-P  
(033783)



**REGULADOR**  
para acetileno  
SH-1320  
(033782)



**REGULADOR**  
para nitrógeno  
SH-1320  
(026918)



**REGULADOR**  
médico  
CGA-FCM-540-M  
(089544)



**CHALECO DE CARNAZA**  
para soldar #5647  
(026907)



**CARETA SOLDAR**  
fibra con vent  
móvil #8115  
(080748)



**SEGURIDAD**

- 1 026906 Guantes cortos de carnaza
- 2 026908 Mangas de carnaza
- 3 026909 Mandil de carnaza

**Equipo oxicorte dinámico**  
EQP-PL-003-V  
(032020)





**JUMPER / ARRANCADOR**  
compresor 12 V 750 Amp SJ1331  
(027973)



**CARGADOR AUTOMÁTICO**  
15 Amp 6/12V SC1360  
(059620)



**FUENTE DE PODER ARRANCADOR**  
para batería 22 Ah 12 V DSR114  
(059619)



**CARGADOR MANTENEDOR  
AUTOMÁTICO**  
10 Amp 12 V SC1339  
(061889)



**CARGADOR AUTOMÁTICO**  
2/10/50 Amp 12 V SC1361  
(061888)



**CARGADOR MANTENEDOR**  
1.5 A 6/12 V SC-1300  
(005455)



**ARRANCADOR CARGADOR MANTENEDOR**  
065524 275/40/6/2 Amp 6/12 V SC1326  
065523 250/50/6/2 Amp 6/12 V SC1325  
021456 250/275/60/20 A mp 12/24 V SC1352



**PROBADOR DE BATERÍAS**  
6/12/24 V  
(068941)



**PROBADOR DE BATERÍAS**  
12 V 100 Amp BT-100  
(021464)



**ABANICO PORTATIL**  
12V SAC-404  
(056006)



**VOLTI-AMPERIMETRO DE GANCHO DIGITAL**

004142 600A - 600V  
060757 TRMS 660A - 750V  
028085 1,200A - 1,000V



**VOLTI-AMPERIMETRO DE GANCHO DIGITAL**

080515 1,000A - 750V  
082100 1,200AC/DC 750V  
080532 600A - 600V



**VOLTI-AMPERIMETRO DE GANCHO DIGITAL**

AC/DC Watt  
TRMS 600A - 600V  
(016877)



**VOLTI-AMPERIMETRO DE GANCHO DIGITAL**

094413 400A - 600V  
092977 600A - 600V  
027703 400A - 600V



**MULTITESTER DIGITAL**

016878 0.01 - 10A 600VRMS  
038000 0.01 - 10A TRMS 1000V



**MULTITESTER DIGITAL INSULADO**

600V 3MΩ  
(016444)



**MULTITESTER DIGITAL**

750V - 200MA - 10A  
(080530)



**MEDIDOR DE CAPACITORES DIGITAL**

20MP - 200PP  
(016447)



**INDICADOR DE NIVEL DE SONIDO**

30 - 130 dB  
(080526)



**MEDIDOR DE LUZ DIGITAL**

004140 20 - 200,000 Lux  
004141 20 - 200,000 Lux



**TERMÓMETRO DIGITAL**

200 °C - 1,370 °C  
328 °F - 1,922 °F  
(004139)



**TERMÓMETRO INFRAROJO**

30 °C - 350 °C  
22 °F - 986 °F  
(016879)

**BOMBA HEAVY DUTY**

055916 12 V

055917 115 V

**BOMBA DE ENGRASE**  
 depósito 11 Lbs manguera 1.5 M  
 (015753)

**PRENSA PARA CARPINTERO**

009397 36" 900mm

009431 60" 1500mm

009442 84" 2100mm

**PRENSA DE BANCO ACERO**

009128 4" 100mm

009129 6" 150mm

009136 8" 200mm

**MEDIDOR DE COMBUSTIBLE 1"**  
 (028080)

**BOMBA DE ENGRASE**  
 depósito 50 Kg con ruedas  
 (035014)

**BOMBA DE ENGRASE**  
 depósito 22 Lbs  
 manguera 2 M  
 (015766)

**BOMBA MANUAL**  
 rotativa profesional 1"  
 (009479)



**BOMBA MANUAL**  
para tanque químico  
(015760)



**BOMBA NYLON**  
para químicos 400 ml  
(009459)

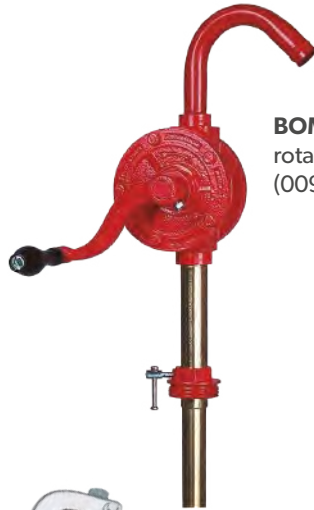

**BOMBA MANUAL**  
rotativa 1"  
(009466)



**ENGRASADORA NEUMÁTICA**  
de 120lbs / 60kg / 16gl  
(009467)

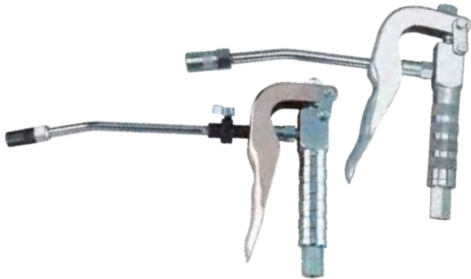

**PISTOLA PARA GRASA**  
con booster  
(030264)



**PISTOLA PARA GRASA**  
profesional  
(030263)



**ENGRASADORA DE MANO**  
500 CC 10mm  
(015752)



**PISTOLA PARA ACEITE**  
con medidor  
(030265)



**PISTOLA PARA COMBUSTIBLE**  
con medidor 3/4"  
(035015)



**PISTOLA PARA COMBUSTIBLE 3/4"**  
(035016)



**COMPRESOR ROTATIVO DE TORNILLO**

- 029053 5HP c/tanque de 80 gals
- 028343 7.5HP c/tanque de 80 gals
- 029054 10 HP c/tanque de 80 gals
- 028344 25HP c/tanque de 120 gals



**COMPRESOR**  
Para odontólogos  
1.5 HP con tanque  
10 gal  
(039569)



**COMPRESOR VERTICAL**  
7.5 HP 80 gal  
(054598)



**JUEGO 4 CONECTORES  
RAPIDOS AIRE**  
(021434)



**LLAVE DE  
IMPACTO**  
1/2"  
(029050)



**TALADRO  
DE AIRE**  
1/2"  
(086968)



**PULIDORA NEUMATICA 5"**  
(086460)



**LLAVE DE IMPACTO**  
(029051)



**GRAPADOR /  
CLAVADORA  
NEUMATICA**  
(056869)



**MAQUINA LAVADO A PRESION**  
4200 PSI  
(056866)



**INFLADOR DE GOMAS**  
Con manómetro presión  
y luz led 12 V  
(058874)



**COMPRESOR**  
2 HP 20 gal  
(099218)



**SANDBLASTER**  
Arena 9 gal  
(081323)



**PISTOLA PULVERIZADORA DE GRAVEDAD**  
(061792)



**REMACHADORA NEUMATICA**  
(028345)



**PISTOLA**  
De alta Presión  
(021424)



**CONJUNTO FILTRO**  
Regulador y lubricador  
(089924)



**MANGUERA**  
1/4" x 50" Espiral  
(021443)



**ACEITE DE COMPRESOR**  
(050967)



**MANGUERA**  
3/8" x 25' azul 300 PSI  
(098003)

**COMBO  
BOMBA SUCCIÓN  
LADRONA 0.5 HP  
+ SWITCH ELECTRÓNICO  
(014757)**



**BOMBA  
DOBLE SUCCIÓN  
1 HP 110 / 220 V  
(052837)**



**BOMBA JET**

096395	0.5 HP 110V/220 V
096396	3/4 HP 110/220 V
096397	1 HP 110/220 V
096398	1.5 HP 220 V
096399	2 HP 220 V



**BOMBA CENTRÍFUGA  
De presión para cisternas**

099668	3 HP 220 V
000964	4 HP 220 V



**BOMBA  
Acero inoxidable  
1 HP 110/220 v  
(096400)**



**BOMBA  
SUMERGIBLE  
Para fuentes  
0.5 HP  
Inoxidable 110 v  
(096391)**



**GRIFO  
Cuello Cisne  
para filtro  
(026930)**

**ESTERILIZADOR  
UV de agua  
2 GPM  
(031445)**



**BOMBA SUMERGIBLE  
Para fuentes  
0.33 HP 110 v  
(010928)**

**HOUSING  
PARA FILTRO  
4.1/2" x 20"  
Transparente  
(037813)**



**HOUSING  
PARA FILTRO  
4.1/2" x 20"  
(099564)**



**HOUSING  
PARA FILTRO  
4.1/2" x 10"  
(099563)**



**HOUSING  
PARA FILTRO  
2.1/2" x 10"  
Transparente  
(099561)**



**CARTUCHO  
Hilo  
4.1/2" X 20"  
(099572)**



**CARTUCHO  
Hilo  
2.1/2" x 20"  
(009904)**

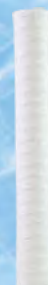

**BOMBA**  
Para jacuzzi  
0.65 HP  
(029593)



**BOMBA PISCINA**  
3 HP 220 V  
(015006)



**BOMBA 0.5 HP + TANQUE PRESURIZADO**  
19 lt vertical  
(C0620)



**BOMBA CENTRÍFUGA**  
De presión para cisternas

052834	5.5 HP 220 V / 3 fases
052835	7.5 HP 220 V / 3 fases
052836	10 HP 220 V / 3 fases



**TANQUE DE AGUA**  
En fibra precargado

081539	20 gal
081540	35 gal
081541	50 gal
010927	65 gal



**FILTRO OSMOSIS RESIDENCIAL**  
50 GPD. C/ UV  
(009926)



**BOMBA 0.5 HP + TANQUE PRESURIZADO ANTICORROSIÓN**  
24 lt + Accesorios  
(014401)



**BOMBAS SUMERGIBLES**

098927	3/4 HP 220 V
098928	1 HP 220 V
098929	1.5 HP 220 V
098930	2 HP 220



**CARTUCHO Hilo**  
2.1/2" x 10"  
(099574)



**FILTRO Polipropileno**  
4.1/2"x20"  
(002729)



**CARTUCHO Sedimento**  
2.1/2"x20"  
(009903)



**CARTUCHO Sedimento**  
2.1/2"x10"  
(023674)



**FILTRO Carbón Sedimento**  
2. 1/2" x 10"  
(009907)



**FILTRO De línea**  
(099583)

**MOTOR DIESEL MULTIPLE**

039138 20HP

039139 22HP

**MOTOR**

050443 Gasolina 6.5HP

057437 Diesel 6.6HP

**VIBRADOR ELECTRIC PARA CONCRETO c/manguera**

057441 1.1/2" 3HP

057442 2" 3HP

**COMPACTADOR**

057435 Motor diesel

057436 Motor gasolina Honda

**MOTOBOMBAS**

039140 Diesel 2"

039141 Diesel 3"

039142 Diesel 4"

050445 Gasolina 2"

050446 Gasolina 3"

**VIBRADOR PARA CONCRETO MOTOR GASOLINA c/manguera**

057439 1.1/2" 5.5HP

057440 2" 5.5HP

**HELICOPTERO PARA ALISAR CONCRETO**

052652 36"

050444 40"

039137 47"

**CORTADORA DE ASFALTO Y CONCRETO**

Motor Honda 15 HP Gasolina  
(064326)



**CEPILLO**

- 039026 12" 2.2KW 220V
- 039025 6" 1HP 110V



**SIERRA DE BANCO**

- 039032 10" 2200W 220V-110V
- 039033 12" 2200W 220V-110V



**HORMIGONERAS REMOLCABLES SM450**

- C0738 Motor gasolina 6.5HP Excalibur
- C0745 Motor diesel 6.6HP Excalibur
- C0737 Motor gasolina 5.5HP Honda



**MAQUINA COMBINADA**  
1.50Kw 220V  
(039030)



**REGRESADORA**  
2HP 220V  
(039031)



**LIJADORA**  
250W 110V  
(039028)



**SIERRA SIN FIN**  
18" 2200W 220V  
(039035)



**LIJADORA**  
550W 110V  
(039029)



**FURADOR**  
750W 110V  
(039027)



**TALADRO DE MESA**  
375W 110V  
(039036)

**TALADRO PEDESTAL**  
375W 110V  
(039037)  
HD 1100W 110V  
(039038)



**SIERRA DE BANDA**  
21" 5HP 230V/60Hz/1P  
(068978)



**SIERRA SIN FIN**  
Horizontal 5" x 6"  
(054063)



**RECOLECTOR DE POLVO**  
1.5HP 110V 1P  
(039899)



**REGRESADORA**  
5HP 220V/60Hz/1P  
(068462)



**SIERRA DE BANCO**  
10" 3HP  
(067074)



**CEPILO DE MESA**  
6"  
(054062)



**TALADRO DE PEDESTAL**  
062086 13" 3/4HP  
068876 20" 1.5HP



**SANDBLASTER PORTABLE**  
20 gls  
(068974)



**GANCHO PARA CADENA**

069202 10mm  
069203 13mm



**GANCHO DE SEGURIDAD GIRATORIO**

073022 10mm  
073023 13mm



**GRILLETE DE ALTA RESISTENCIA**

069208 1/2" 2T  
069209 3/4" 4.75T  
069210 1" 8.75T



**GANCHO DE AGARRE CLEVIS**

073024 10mm  
073025 13mm  
073026 16mm



**MORDAZA UNIVERSAL**

2T (0-25mm)  
(069217)



**ENLACE DE CONEXIÓN TIPO EUROPEO**

073003 10mm  
073004 13mm  
073005 16mm  
073006 20mm



**GANCHO DE SEGURIDAD CLEVIS**

073018 13mm  
073019 16mm  
073020 18mm  
073021 22mm



**GRAPA PARA JALAR CABLE**

2T (2-26mm)  
(069206)



**ENLACE SUB-MASTER**

073007 10mm  
073008 13mm



**ENLACE DE CARGA TIPO CHICHARRA**

073011 5/16" - 3/8"  
073012 3/8" - 1/2"  
073013 1/2" - 5/8"



**PLATAFORMA FIJA**

12T  
(069220)



**PLATAFORMA MÓVIL**

12T  
(069222)



**ENLACE DE CARGA ESTANDAR**

073009 5/16" - 3/8"  
073010 3/8" - 1/2"



**CARRETILLA HIDRÁULICA**

2.5Tx550mm  
(069180)



**GRÚA PLEGABLE**

069213 2T (85-2000mm)  
069214 3T (0-2000mm)



**ESCALERA TIJERA FIBRA DOBLE**

069194 4' 072995 8'  
069195 5' 072996 10'  
069196 6' 072997 12'  
069197 7' 072998 14'



**ESCALERA TELESCÓPICA PLEGABLE**

073014 8.5'  
073015 9.5'  
073016 10.5'  
073017 12.5'



**ESCALERA EXTENSIÓN**

072999 20'  
073000 24'  
073001 28'  
073002 32'



### DIFERENCIAL ELÉCTRICO

- 038190 1 ton 30' alzada 220/60/1
- 038191 2 ton 30' alzada 220/60/1
- 038192 3 ton 30' alzada 220/60/1
- 050516 2 ton 30' alzada 220/440/60/3
- 050517 3 ton 30' alzada 220/440/60/3
- 038193 5 ton 30' alzada 220/440/60/3
- 065289 7.5 ton 30' alzada 220/440/60/3
- 065290 10 ton 30' alzada 220/440/60/3



### DIFERENCIAL DE CADENA MANUAL

- 050518 0.5 ton 10' alzada
- 050519 1 ton 10' alzada
- 050520 1.5 ton 10' alzada
- 054504 2 ton 10' alzada
- 050521 3 ton 10' alzada
- 050522 5 ton 10' alzada
- 038194 10 ton 10' alzada



### CADENA DE CARGA

8 mm x 24 mm grado  
80 AW-80-08  
(050550)

### CADENA DE MANO

5 mm x 23.7 mm CB-B  
(052746)



### DIFERENCIAL ELÉCTRICO DE CABLE

con trolley 3 ton 12M alzada  
220V/60/3  
(065290)



### WINCHE ELÉCTRICO DE CABLE

- 065291 500Kg 110V/60Hz/1P
- 065292 1000kg 110V-220V/60Hz/1P



### PULLER PALANCA

- 050523 0.75 ton
- 050524 1.5 ton

### PULLER DE CABLE

1.5 ton HRP015  
(050549)



### TROLLEY ELÉCTRICO PARA DIFERENCIAL

- 050525 3 ton 220/440/60/3
- 050526 5 ton 220/440/60/3



### TRACTEL DE CABLE

- 054508 0.8 ton x 20 M WRP08
- 050532 1.6 ton x 20 M WRP16
- 050533 3.2 ton x 20 M WRP32
- 058285 5.4 ton x 20 M WRP54



### TROLLEY PARA DIFERENCIAL

- 050527 0.5 ton
- 050528 1 ton
- 050529 2 ton
- 073027 3 ton



### TROLLEY DE CADENA PARA DIFERENCIAL

- 050530 5 ton
- 050531 10 ton



### WINCHE DE FRENO MANUAL

- 054505 1200 Lbs 10 M cable
- 054506 1800 Lbs 10 M cable
- 054507 2600 Lbs 10 M cable



**EQUIPO SOLDAR Y CORTAR**  
#0384-2036  
(024739)



**EQUIPO DE CORTAR**  
#0384-2060  
(010767)



**REGULADOR DE OXÍGENO**  
2.1/2" HD #0781-0527  
(021724)



**REGULADOR DE ACETILENO**  
2.1/2" HD #0781-0584  
(007568)



**REGULADOR DE ACETILENO**  
#0781-9420  
(017536)



**REGULADOR DE OXÍGENO**  
#0781-9415  
(017537)



**BOQUILLA PARA CORTAR  
CON GAS PROPANO**

- 021719 #1 1-GPN
- 021720 #2 2-GPN
- 021721 #3 3-GPN
- 010755 #4 4-GPN
- 001930 #5 5-GPN
- 015013 #6 6-GPN



**BOQUILLA PARA CORTAR  
CON OXI-ACETILENO**

- 021716 #1 #1-101
- 021717 #2 #1-101
- 021718 #3 #1-101
- 010752 #4 #1-101



**ANTORCHA PARA CORTAR**  
21" 0381-1480  
(000619)



**JUEGO ARRESTA LLAMA**  
2/1 para regulador  
VIC-0656-0007  
(027116)



**JUEGO ARRESTA LLAMA**  
2/1 para antorcha  
VIC-0656-0006  
(027115)



**MANGUERA DOBLE PARA  
ACETILENO**

- 096877 1/4" x 50' RH-2103
- 096876 1/4" x 25' RH-2102
- 099176 1/4" x 100' RH-2105



**EQUIPO PARA SOLDAR Y CORTAR**  
Portátil con tanques 0384-0936  
(024741)



**SIERRA DE BANDA**  
110V/60Hz/1P  
(071260)



**CORTADOR/DOBLADOR DE VARILLAS**  
1" 110V/60Hz/1P  
(071257)



**TALADRO MAGNÉTICO**

065554 5/8"  
065555 1.1/8"  
071255 3/4" 110V/60Hz/1P



**JUEGO TERRAJAS MANUAL**

059571 3/8" a 1.1/4" NPT  
059572 3/8" a 2" NPT



**MÁQUINA DESTAPAR TUBERÍAS**

3/4" a 6" 110V/60Hz/1PH  
(059576)



**DESTUPIDOR TIPO TALADRO**

3/4" 2.1/2" 110V/60Hz/1P  
(071256)



**PLANCHA PARA SOLDAR TUBERIA**

059584 PPR 2"  
071254 PPR 4" 220V/60Hz/1P



**CORTADORA DE TUBOS**

1/8" a 2"  
(059580)



**SOPORTE PARA TUBOS 12"**

(059578)



**PRENSA PARA TUBOS**

1/8" a 6"  
(065564)



**PRENSA PARA TUBOS**

1/8" a 2"  
(059581)



**CORTADOR/PERFORADOR**

(065553)



**ROSCADORA**

059564 1/2" a 2" NPT 110V/60Hz/1PH  
059565 1/2" a 3" NPT 110V/60Hz/1PH  
059566 1/2" a 4" NPT 110V/60Hz/1PH



**RANURADORA HIDRÁULICA**

2" a 6" y 8" a 12"  
(059575)



**DOBLADOR HIDRÁULICO DE TUBOS**

1/2" a 2"  
(059583)



**ALICATE DE CORTE**  
diagonal 8  
(083315)



**PINZA CORTACABLES**  
9" #509  
(000622)



**PINZA DE ELECTRICISTA**  
jalaguia 9" D215-9  
(075487)



**ALICATE ELÉCTRICO**  
HD 9" KT201-9  
(020964)



**CORTACABLES**  
10" sist. matraca  
#5750  
(008091)



**LLAVE AJUSTABLE**  
(1000V Cromada con mango T aislado)  
000628 10"  
075488 12"



**ALICATE ELÉCTRICO**  
9" Aislado 1000V  
KTA201-9  
(083316)



**PINZA PELA ALAMBRES**  
automática cal.  
10-22  
(000630)



**CUCHILLA PELADORA CURVA**  
007907 A1570-3  
083320 #1570-3



**JUEGO DE LLAVES HEXAGONALES**  
13/1 con punta bola  
#717  
(075492)



**TIJERAS**  
industriales y/o  
sastre 8" #505-8  
(075493)



**LLAVE ALLEN**  
(con mango T aislado)  
075489 1/4"  
075490 5/16"  
075491 3/8"



**GUÍAS JALACABLES**  
(Alambre Plano)  
000633 1mmx3mmx30M  
000634 1mmx3mmx15M



**DOBLADOR DE TUBOS**  
1/2" #12-50  
(083321)



**BANDOLA LINIERO**  
c/gancho y doble  
seguro #5295-16D  
(018013)



**ARNÉS DE CUERPO COMPLETO**  
#5435  
(083317)



## ARRANCADOR/JUMPER DE BATERÍAS

12/24V Lítio 12/24V  
9000/4500A 110/220V  
Startzilla 9024 XT  
(043797)

12V 4000A 110/220V  
Startzilla 4012 XT  
(043796)

## PROBADOR DE BATERÍAS

12V  
BTS350  
(043798)

12V  
compatible USB  
STS 700  
(043799)



## CARGADOR/MANTENEDOR DE BATERÍAS



6/12V 0.75A 110/220V  
Defender 8  
(043787)

## ARRANCADOR/JUMPER DE BATERÍAS

12V 1000A  
Cargador tipo C  
de 1000 mAh  
Drive Mini 12  
(043792)

12V 1200A  
110/220V  
Drive 9000  
(043793)

12V 2000A  
110/220V  
Drive Pro 12  
(043794)

12/24V 2200A  
110/220V  
Drive Pro 12/24  
(043795)

## CARGADOR/MANTENEDOR DE BATERÍAS



12/24V 8/4A 110/220V  
Defender 20  
(043788)



6/12V 4A 110/220V  
T-Charge 12 Evo  
(043789)



12/24V 8/4A 110V  
T-Charge 20 Evo  
(043790)



12/24V 16/8A 110V  
T-Charge 26 Evo  
(043791)



**ASPIRADORA DE POLVO**  
1 gal 1 HP Potencia Pico (PHP)  
(059520)



**ASPIRADORA DE POLVO**  
2.5 gal 2 HP  
(059522)



**ASPIRADORA DE POLVO**  
5 gal 2 HP  
(059524)



**ASPIRADORA DE POLVO**  
12 gal 5.5 HP  
(059526)



**ASPIRADORA DE POLVO**  
14 gal 6.5 HP  
(059519)



**ASPIRADORA DE POLVO  
ACERO INOXIDABLE**  
12 gal 5.5 HP  
(071560)



**ASPIRADORA DE POLVO  
ACERO INOXIDABLE**  
8 gal 4 HP  
(062242)



**BOLSA REPUESTO  
REUSABLE 3/1**  
(090971)



**FILTRO PARA  
ASPIRADORAS**  
030003 #9030436  
069491 #90398



**FILTRO FOAM PARA  
ASPIRADORA**  
030004 #9058536  
056061 #905-26-36



**MANGUERA ASPIRADORA**  
067449 8Pie x 1.25Pulg  
067450 8Pie x 2.1/2Pulg



**BOLSA DE REPUESTO 3/1**

039112	1-1.5 gal
059523	2-2.5 gal
036925	10-14 gal
045967	15-22 gal







## HORMIGONERA REFORZADA BT 400 SR

(097867)

### MOTOR DE GASOLINA



**HONDA** GX 160  
5,5 hp

 <b>DOSIS</b>	35 Kg + 35 Kg	 <b>CAPACIDAD DEL TROMPO</b>	360 L
 <b>SIN MOTOR</b>	168Kg	 <b>MÁX. DE MEZCLA</b>	290 L
 <b>PRODUCCIÓN POR HORA</b>	2,60 m <sup>3</sup> /h	 <b>DIMENSIONES</b>	1810 x 1100 x 1650 mm

## HORMIGONERA REMOLCABLE BP 400 RLAT EVO

(097868)

### MOTOR DE GASOLINA



**HONDA** GX 160  
5,5 hp



 <b>CANTIDAD</b>	1 funda de 42 Kg + 1 funda de 28 Kg	 <b>CAPACIDAD DEL TROMPO</b>	360 L
 <b>SIN MOTOR</b>	251 Kg	 <b>MÁX. DE MEZCLA</b>	290 L
 <b>PRODUCCIÓN POR HORA</b>	2,60 m <sup>3</sup> /h	 <b>DIMENSIONES</b>	1800 x 1100 x 1600 mm



**EQUIPO DESABOLLADOR  
HIDRÁULICO**  
10 ton GC-10  
(084146)



**CILINDRO SIMPLE**  
31 ton retorno por  
muelle CSRA-31B  
(098965)



**CILINDRO SIMPLE**  
31 ton retorno por  
gravedad CSB-31B  
(097775)



**CILINDRO EXTRAPLANO**  
55 ton CSE-55  
(013338)



**GATO HIDRÁULICO  
TIPO RANA**

085597 2 ton  
024222 10 ton  
060787 20 ton



**BOMBA MANUAL**  
400cc BM-04  
(094398)

**GATO HIDRÁULICO  
PARA TRANSMISIONES**

hasta 1 ton GCB-2  
(081055)



**GATO HIDRÁULICO  
BOTELLA**

005430 10 ton  
005433 20 ton  
005439 50 ton



**DOBLADOR HIDRÁULICO  
DE TUBOS**  
20 ton 3Pulg DR-3  
(021978)



**GRÚA PLEGABLE**  
1 ton CRV10  
(021501)



**PRENSA HIDRÁULICA**

039555 20 ton cilindro fijo PRC20  
085593 30 ton KPD-30  
085594 50 ton KPD-50



### SIERRA SIN FÍN

Para cortar carne 5/8"  
(096085)

### SIERRA CINTA DE ACERO

Para madera 2"x0.55"x3th  
(096085)

### ROLLO SIERRA CINTA DE ACERO FLEX-BACK

072080 3/4"x0,032"x8T

072079 1"x0,035"x8T



### SEGUETA BI-METÁLICA

084817 1/2"x18th

026535 1/2"x24th

026536 1/2"x32th



### SEGUETA PARA MÁQUINA

098435 12"x1"x 14Th

096655 14"x1"x10th

084836 17"x1.1/4"x6th

084838 18"x1.1/2"x6th



### CALIBRADOR PIE DE REY

096244 0-200mm - 0-8"

096245 0-300mm - 0-12"



### CALIBRADOR PIE DE REY

6" con reloj  
(096231)



### PILOTE SIERRA

A1  
(096106)

### PILOTE SIERRA

A2  
(096107)



### COMPÁS PARA METAL

exterior 6"  
(096236)



### COMPÁS PARA METAL

de punta 6"  
(096239)



### MICRÓMETRO

096201 0-25 mm

096202 25-50 mm

014839 3"-4"



### BURBUJA TRANSVERSAL

para nivel 200mm - 8"  
(069322)



### SIERRA COPA

(Gran variedad)

096092 3/4"

095634 1"

096248 2"

096101 3"

037235 4.1/2"



### JUEGO DE SIERRAS COPA

(030709)



**CEPILLO COPA DE ACERO**

- 020135 3"x5/8"
- 020136 4"x5/8"
- 020137 5"x5/8"
- 095180 6"x5/8"



**CEPILLO COPA TRENZADO**

- 016315 3"x5/8"
- 020138 4"x5/8"
- 020139 5"x5/8"



**CEPILLO CIRCULAR DE ACERO**

- 020130 5"x1" x1/2"
- 020131 6"x1"x5/8"
- 016312 6"x1"x5/8" inox.
- 020132 8"x1.1/8"x3/4"
- 020133 10"x1.3/8"x3/4"



**CEPILLO CIRCULAR DE NYLON**

- 016313 6"-4H
- 016314 6"-8H



**CEPILLO CIRCULAR CON EJE DE 1/4**

- 020148 2"
- 020150 3"
- 000130 4"



**CEPILLO CON EJE DE 1/4**

- 020151 2"
- 020152 3"



**CEPILLO CIRCULAR DE ACERO TRENZADO**  
6"x7/8"x5/8"  
(020134)



**CEPILLO CIRCULAR CON EJE DE 1/4**

- 020140 #1
- 020143 #4
- 020144 #5



**CEPILLO PARA LIMPIAR TUBOS**

- 020153 1/4" y 3/4"
- 020154 1.3/16"
- 020155 2"
- 020156 3"



**CEPILLO FIBRA FINA INOXIDABLE**  
con mango plástico  
(084930)



**CEPILLO FIBRA FINA ACERO**  
con mango plástico  
(084929)



**CEPILLO DE ACERO**  
con mango de madera  
(020127)



**DIFERENCIAL**

021471	1/2 ton con 8 1/2' alzada
021472	1 ton con 8 1/2' alzada
080791	1.1/2 ton con 8.1/2' alzada
080792	2 ton con 10' alzada
080793	3 ton con 10' alzada
080794	5 ton con 10' alzada
080795	10 ton con 10' alzada



**TROLLEY**

016019	1 ton
016020	2 ton
061732	5 ton Plain
080801	5 ton
015339	10 ton

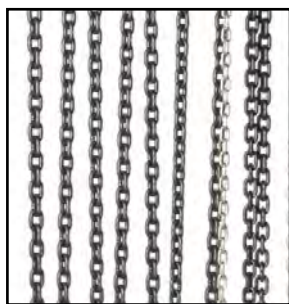

**CADENA DE CARGA**

021481	6.3mm x 19.1mm
021482	7.1mm x 21.0mm
086095	7.9mm x 23.0mm
086096	9mm x 27.0 mm



**PULLER (Come Along)**

080796	0.8 ton 5' alzada
080797	1.1/2 ton 5' alzada
080798	3 ton 5' alzada
080799	6 ton. 5' alzada



**TRACTEL DE CABLE (WINCHE)**  
6 ton  
(021473)



**EXTRACTOR EN LINEA**  
 BOX BV 7/7 -25/25  
 0.25 - 11 KW  
 1000 - 21194 CFM



**EXTRACTOR INDUSTRIAL  
 DE AIRE PARA PARED**  
 HJB 110 - 120  
 0.75 - 1.1 KW 19022 - 22830 CFM



**EXTRACTOR DE AIRE  
 PARA TECHO**  
 BT ROOF 200 - 315  
 0.205 - 0.413 KW 670 - 1324 CFM



**EXTRACTOR DE AIRE  
 PARA TECHO**  
 CTH2 400 - 800  
 0.55 - 5.5 KW 3001 - 17472 CFM2

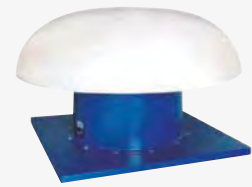

**EXTRACTOR DE AIRE  
 PARA TECHO**  
 HMTE 25 - 80 0.08 - 4 KW  
 701 - 18222 CFM



**EXTRACTOR EN LINEA**  
 CHELYS 100 - 250  
 0.03 - 0.17 KW  
 123 - 673 CFM



**EXTRACTOR DE AIRE  
 PARA BAÑO**  
 LARUS 4" - 5" 14.1 - 16.7 W  
 62 - 94 CFM



**EXTRACTOR DE AIRE  
 PARA BAÑO**  
 LIBELLUM 4" 13 W 64 CFM



**TURBINA EJE LIBRE**  
 Sin motor  
 BV 7/7 - 12/12



**EXTRACTOR DE AIRE PARA PARED**  
 HBJM PLUS 30 - 50 0.12 - 0.25 KW  
 1560 - 4267 CFM



**EXTRACTOR CENTRIFUGO**  
 MA 26 - 31 0.55 - 2.2 KW  
 235 - 1277 CFM

# KÖNIN



**TELEVISOR LED  
4K FHD 55"**  
3 HDMI  
2 USB  
(057527)

**TELEVISOR LED  
FULL HD 43"**  
Ultra Slim  
2 HDMI  
3 USB  
(064000)

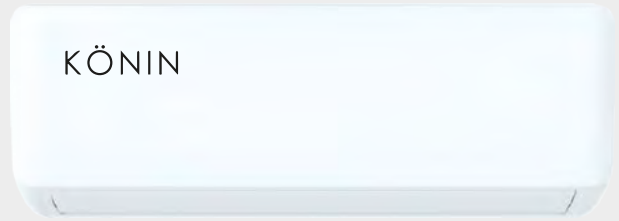

## KÖNIN

**ACONDICIONADOR  
DE AIRE**  
12,000 BTU (000710)      24,000 BTU (052021)

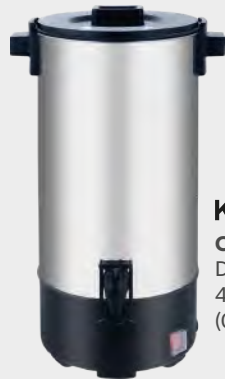

**Kitchen PRO  
CAFETERA ELÉCTRICA**  
De aluminio  
40 tazas - 95W  
(068098)



**Galanz**  
**NEVERA  
EJECUTIVA**  
4.5 pies cúbicos  
Con llave  
Negro /Gris  
(050065)



**BEBEDERO**  
Blanco  
De sobre mesa  
Termoeléctrico  
(061268)



**Kitchen PRO  
BEBEDERO**  
Color plateado  
Agua fría, normal y  
caliente  
Botellón oculto  
(068757)



### Hamilton

**ABANICO DE PARED**  
20" - 1530 RPM      26" - 1350 RPM  
100 w - Giratorio      160 w - Giratorio  
(051161)      (051162)  
30" - 1400 RPM  
230 w - Giratorio  
(051163)



### Hamilton

**ABANICO DE PEDESTAL**  
20"  
1400 RPM 140 w  
Giratorio  
(051164)  
26"  
1400 RPM 190 w  
Giratorio  
(051165)  
30"  
1400 RPM 230 w  
Giratorio  
(051166)



**PALETIZACIÓN CONVENCIONAL**



- Seguridad y Fiabilidad
- Máximo aprovechamiento del espacio
- Diseño adaptable a distintos productos, pesos y dimensiones
- Solución optimizada para picking y paletización para cargas ligeras y pesadas, sin tornillos y con perfecto acabado

**MINI-RACK SL 6,000**



**ECO SL 4,000**



**RANURADO**



## Paletas Plásticas

• 40" X 48"

- MAXIMIZA TU LOGÍSTICA DE ENVÍOS Y RETORNOS DE MERCANCÍA
- REDUCE TUS COSTOS DE EMBALAJE

**PROHIGIÉNICA  
ENTRADA LIBRE**  
(065196)



Sistema de Protección  
Doble Pared

Diseño Único

**DOBLE PATA**  
(058731)

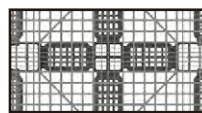

Diseño higiénico



6" HD / 5" SD

**APILABLE**  
(058732)



**APILABLE  
Para trabajos ligeros**  
(078951)

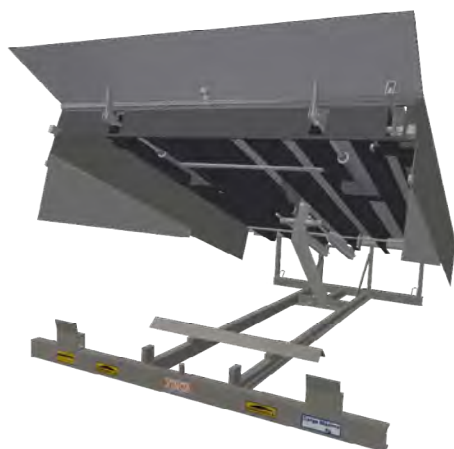

**MUELLE DE CARGA**  
(047388)

- 1,800mm x 2,495mm
- 6,000 Kg

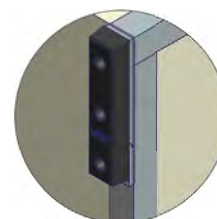

**TOPE DE GOMA**  
(047389)

- 400mm x 80mm

# SEGURIDAD



**CERRADURA**  
Dural  
Para puerta  
(011459)



**CERRADURA**  
Dural  
Para puerta  
Con llave  
(059745)



**CERRADURA**  
Dural  
Para puerta  
(059749)



**CIERRAPUERTAS**  
(002927)



**CERRADURA DE CONJUNTO**  
Entrada principal  
(050220)



**CERRADURA**  
Dural  
Eléctrica  
Izquierda  
(025783)



**CERRADURA**  
Sobreponer  
Derecha  
(027991)  
Izquierda  
(027992)



**BARRA ANTIPÁNICO**  
60 - 100 cm  
(031888)



**CANDADO**  
110-60 (002422) 110-50 (002421) 110-40 (002420)



**CANDADO**  
Dural  
Cuello largo  
50 mm  
(096126) 40 mm (096125)



**CERRADURA TÁCTIL**  
• Con manilla  
• En idiomas: Español e Inglés  
• Hasta 25 usuarios con claves diferentes  
• Sonido interno  
(017076)



**MIRILLA DIGITAL 110°**  
• Para puertas 32 a 50 mm  
• Baterías AA incluidas (4)  
• Almacena 6,000 fotos con tarjeta microSD 512Mb (incluida)  
(051236)



**CAJA PARA LLAVES**  
48 unidades  
250 x 180 x 80 mm  
(019095)  
93 unidades  
300 x 240 x 80 mm  
(019096)



**CAJA CHICA**  
90 x 200 x 160 mm  
YFC-20 (026496)  
90 x 200 x 180 mm  
YFC-25 (026497)  
90 x 300 x 240 mm  
YFC-30 (026498)



**CAJA FUERTE**  
990 x 600 x 610 mm  
(019088)



**CAJA FUERTE**  
Deposito  
DP60  
(039096)



**CAJA FUERTE**  
14" x 10" x 10"  
EUD25  
(039094)

16" x 9" x 13"  
EUD23  
(039093)

12" x 8" x 8"  
EUD20  
(039092)



**CINTA AMARILLA PRECAUCIÓN**  
3" x 250 m  
(018577)



**CASCOS PLÁSTICOS**  
Ajustables  
Varios colores  
(002514)



**ESPEJO ESFÉRICO**  
180°  
(018574)



**ESPEJO ESFÉRICO**  
360°  
(018575)



**FAJA SOPORTE**  
Tallas M-L-XL  
(082459)



**TRAJE DE AGUA**  
2 piezas  
Size M, L, XL  
(030472)



**CORREA ESLINGA**  
Para carga  
3" x 4 m 3000 kg (030460)  
4" x 5 m 4000 kg (030461)



**ARNÉS DE SEGURIDAD**  
(030457)

**AMORTIGUADOR DE CAÍDA**  
Línea de vida  
(015631)



**CINTURÓN DE SEGURIDAD**  
(002980)



**CORREAS DE AMARRE PARA CARGA**

1" x 5 m 750 Kg (015623)	1.1/2" x 10 m 3000 Kg (030459)	2" x 15 m 5000 Kg (015626)	3" x 15 m 7500 Kg (083716)
--------------------------------	--------------------------------------	----------------------------------	----------------------------------



**REDUCTOR DE VELOCIDAD**  
Corrugado  
De goma  
49 x 42 cm  
(029724)

**TERMINAL**  
Reductor de velocidad  
(029725)



**TOPE (PARACHOQUES)**  
Con panel reflectivo  
(034204)



**TOPE**  
Para parqueo  
Fibra plástica  
180 cm  
(018567)



**BARRA**  
para cono de tráfico  
120 cm  
(018576)

**CONO**  
Para tráfico PVC  
75 cm  
flexible al impacto  
(018579)



**PROTECTOR**  
De esquina  
80 x 10 x 1 cm  
(018569)



**POSTE**  
Flexible plástico  
80 cm  
(018570)



**CONO ROJO**  
Para tráfico con banda reflectiva y base de goma  
45 cm  
(051383)



**MALLA**  
Para construcción  
42" x 164'  
(013818)



**DISPENSADOR**  
Para jabón líquido  
Blanco (051846)  
Negro (051847)

**DISPENSADOR DE PAPEL TOALLA**  
(013583)

**DISPENSADOR DE SERVILLETAS**  
Blanco (051844)  
Negro (051845)

**DISPENSADOR DE PAPEL Jumbo**  
Blanco (051842)  
Negro (051843)



**PAPELERA INOXIDABLE**  
5 Lt (031917)    12 Lt (031918)

20 Lt (031919)    30 Lt (031920)

**EKO** SENSIBLE  
ECO  
LIVING



**ESPEJO 50''x 70'' + SET DE ACCESORIOS 6/1**  
Cromo (C0706)



**LAVAMANOS**  
Con pedestal  
Blanco (096680)  
(008380)

**ORGANIZADOR**  
Para baño  
Cromo (008318)

**INODORO**  
Con tapa  
Blanco (032252)

**BOTIQUÍN**  
Blanco  
Para baño  
2 puertas (001824)

**ORGANIZADOR**  
Para baño  
Cromo (014932)

**BARRA DE CORTINA**  
Reforzada 6'  
(001088)

**DUCHA HIGIÉNICA**  
(Bidet)  
Blanca (058903)

**ESCOBA**  
Con mango metálico  
(011356)

**ESCOBILLÓN**  
con mango 34 cm  
(011370)

**PAPELERA**  
50 lt  
(055175)

**ZAFACÓN**  
45 gal  
Con tapa y ruedas  
(007388)

**ESCURRIDOR**  
De agua metálico  
75 cm  
(037452)

**ESCURRIDOR**  
De agua metálico  
45 cms  
(032183)

**SEÑAL PISO MOJADO**  
(055178)

**DESARAÑADOR**  
Con palo extensible  
(011366)

**RECOGEDOR DE BASURA**  
Con goma Azul  
(037455)

**CUBETA EXPRIMIDORA**  
35 lt  
(055177)

**ZAFACÓN**  
Con pedal  
120 lt  
(055172)

**ZAFACÓN**  
Con pedal  
240 lt  
(055171)

**KÖNIN ASPIRADORA**  
Color blanco  
Recolector de cable automático  
Filtro de tela reutilizable  
Cepillo para alfombras graduable  
1200 w potencia  
Manguera de alta resistencia y flexibilidad  
Tubos plásticos extensibles  
(056622)

Colores Disponibles:  
● ● ●

## ALMACENAMIENTO Y ORGANIZACIÓN

## ESCALERA TIJERA

**ESCALERA**  
2 peldaños  
(057988)

**ESCALERA TIJERA FIBRA 4'**  
(017457)

**ESCALERA TIJERA FIBRA 6'**  
(017458)

**ESCALERA TIJERA**  
Aluminio 3'  
(082012)

**Aluminio 5'**  
(004804)



**FREGADERO DOBLE**  
Inoxidable  
33" x 19" x 7"  
(015074)

**FREGADERO DOBLE**  
Inoxidable  
33" x 22" x 7"  
(005204)



**FREGADERO DOBLE**  
32 1/4" x 18 1/8" x 8"  
Bajo Encimera (tope)  
(005190)



**TRITURADOR**  
De desperdicios  
Para fregadero  
(034719)

**FREGADERO DOBLE**  
Inoxidable  
33" x 22" x 6"  
(005211)



33" x 19" x 6"  
(005210)

**FREGADERO DOBLE INOXIDABLE**  
Extrareforzado / Profundo  
1 hoyo / 3 hoyos  
33" x 22"  
(039894)



**FREGADERO PARA BAR**  
Inoxidable  
(055945)



**FREGADERO SENCILLO INOXIDABLE**  
Con escurridor  
31" x 19"  
(093432)  
(093433)



**FREGADERO REDONDO**  
Inoxidable  
Diámetro 20" x 7"  
(019391)



**LLAVE**  
Para fregadero  
(027287)



**MEZCLADORA**  
Para fregadero de bar  
(006835)



**MEZCLADORA**  
Para fregadero  
(006966)



**MEZCLADORA**  
Para fregadero  
Cuello alto 8"  
(022010)

